

AC LEAKAGE CLAMP TESTER

MCL-800D+ / MCL-800DX / MCL-800DXR

Instruction manual

This instruction manual explains how to use your AC LEAKAGE CLAMP TESTER (MCL-800D+, 800DX, 800DXR).

Before using, read through this manual to reduce the risk of fire , electric shock, and/or injury.

And save it together with the product so that you can refer to the manual as necessary.

MULTI MEASURING INSTRUMENTS Co., Ltd.

1-26 Kanda Sakuma-cho Chiyoda-ku, Tokyo 101-0025, Japan
Akihabara Murai-Bldg.7F

Phone: +81-3-3251-7016 Fax.: +81-3-3253-4278

SAFETY PRECAUTIONS

- Read these Safety Precautions carefully to use the instrument properly.
- The following warning and precaution are intended to prevent danger and damage to the user and those around the user.



WARNING identifies that incorrect handling may cause danger to the life and body of the user.



CAUTION identifies that incorrect handling may cause damage of the instrument or insufficient performance.

- For safe use, the following symbols are indicated on the instrument and in the instruction manual.



This symbol indicates that you must handle with care. The symbols are indicated on the places where you must refer to the instruction manual to protect the human body and the instrument.

- The following symbol indicates the standard applied.



The symbol indicates that the Bluetooth wireless technologies are employed.

Trademarks (TM, (R) mark, etc. are not specified in this manual.)

- Bluetooth is a trademark of Bluetooth SIG, Inc.
Multi Measuring Instruments Co., Ltd. uses it under a license agreement with the company.
- Android and Google Play are trademarks of Google LLC
- The iOS trademark is used under a license agreement with Cisco Systems, Inc. USA.
- iPhone, iPad, iPad mini and iPod Touch are trademarks of Apple Inc., registered in the US and other countries.
- App Store is a service mark of Apple Inc.



WARNING

To prevent electric shock.

- For safety reasons, use the instrument under a low-voltage circuit of AC600V or less.
Check the circuit voltage before measurement.
- Do not clamp any bare wire.
- Do not measure when the CT or the body is damaged nor the battery cover is removed.
- Do not operate with wet hands, including when battery replacement.
Also do not use in extremely humid places or when the instrument body is wet as well.
- Do not disassemble or modify the instrument.



CAUTION

- Wipe the instrument gently with a soft cloth moistened with a small amount of water or neutral detergent, when it gets dirty. Do not use any abrasives or organic solvents.
- Do not use or leave the instrument in a place with excessive humidity, vapor, excessive dust, fine powder, gas containing salt / sulfur / ammonia, explosive gas, harmful smoke, or strong ultraviolet rays.
- Do not apply any input current exceeding the measuring range to the instrument.

1. OVERVIEW

This instrument is a high-accuracy clamp-type leakage current meter that greatly improved convenience using the latest technology.

Features

- Since the influence from the external magnetic field is slight, a minute current can be measured accurately even near a motor or other wiring.
- The iron core made of a special alloy that does not rust for a long time use provides less aging stable accuracy.
- The filter function allows you to know the amount of high frequency content in the leakage current.
- This instrument has a Bluetooth communication function. It communicates with a smartphone / tablet with the dedicated application "Multi-Tracer" installed, and can display measured values or save them on a server. (Only applicable with MCL-800DX and MCL-800DXR)

2. SPECIFICATIONS

2-1 Performance

2-1-1 Current measurement accuracy

Conditions 23 °C ± 5 °C , 80 %RH (No condensation)

50 / 60 Hz (Sine wave) Location of the wire to be measured: at the center of the CT

Coupling type : AC coupling

Crest factor : 2.5 or less up to 200A range (at full scale input)

(Only MCL-800DXR) 1.41 or less in the range of 1000A (at full scale input)

Range	Resolution	Measuring range	Accuracy
20 mA	0.01 mA	0.10 mA to 22.00 mA	±2 %rdg ± 5 dgt
200 mA	0.1 mA	1.0 mA to 220.0 mA	
2 A	0.001 A	0.01 A to 2.200 A	
20 A	0.01 A	0.10 A to 22.00 A	
200 A	0.1 A	1.0 A to 220.0 A	
1000 A	1 A	10 A to 1000 A	

* When the value is less than 10 counts in each range, "0" is displayed.







2-1-2 Temperature and humidity measurement (approximate value)

Displayed through Multi-Tracer. (Only applicable with MCL-800DX and MCL-800DXR)

2-2 General Specifications

Measurement functions	Leakage current (I _o), Load current (I)	
CT inner diameter	74 x 80 mm	
Measurement type	CT clamping	
Mechanical structure	One end movable split core clamp	
Display	4-digit LCD (with units, symbols) Auto Power OFF indication "APO" Auto-range indication "AUTO" Over range indication "OL" Data hold indication "DH" Filter mode indication "FL" MAX hold indication "MAX" Low battery indication "🔋"	
Range	Auto-range, Manual-range (20 mA / 200 mA / 2 A / 20 A / 200 A / 1000 A) * Only in the manual range (except for 1000 A range), up to 110% of the set range can be displayed. (except for 1000 A range)	
Sensing method	MCL-800D+, MCL-800DX: RMS-converted average-detected value MCL-800DXR: Analog-operated true RMS value	
A-D conversion method	Integral type	
Sampling rate	Approx. 2 times / sec.	
Applicable circuit voltage	Low voltage circuit 600 V ac or less (insulated wire)	
Operating temperature and humidity range	0 °C to 50 °C , ≤ 85 %RH (No condensation)	
Storage temperature and humidity range	-10 °C to 60 °C , ≤ 80 %RH (No condensation)	
Operating conditions	Indoor only, Altitude: ≤ 2,000 m, Pollution degree: II	
Overvoltage category	CAT III 300 V	
Withstand voltage	3700 V, 1 minute (between the core metal part and the grip part)	
Power source	Alkaline battery 1.5 V (LR03) 3 pieces	
Battery life for continuous use (23 °C ± 5 °C reference value)	MCL-800D+	Approx. 200 hours
	MCL-800DX, 800DXR	Approx. 200 hours (Under the condition that no dedicated application "Multi-Tracer" communication is activated) Approx. 100 hours (Under the condition that dedicated application "Multi-Tracer" communication is activated or waiting for being paired.)
Dimensions / mass	138 (W) x 237 (H) x 46 (D) mm Approx. 650 g (including batteries and strap)	
Accessories	3 pcs of alkaline batteries (LR03), Hand strap, Carrying case, Instruction manual	

2-3 Description of functions

Filter	<p>A low-pass filter (quadric LPF, $f_c = 150$ Hz) is inserted into the signal to be measured to enable measurement with suppressed high-frequency components.</p> <p>The Filter button  turns ON / OFF the function.</p>
Data hold	<p>The display value at anytime you like can be frozen. This function is convenient for measurements where it is difficult to see the display such as dark or narrow places.</p> <p>The Data Hold MAX Hold button  turns ON / OFF the function.</p>
MAX hold	<p>The maximum measured value after you activate the function is held.</p> <p>The Data Hold / MAX Hold button  turns ON / OFF the function.</p> <p>* This function does not work in the auto-range.</p>
Low battery indication	<p> lights up when the battery voltage drops to a certain level. Replace the batteries with new ones as soon as possible.</p>
Auto Power OFF	<p>The instrument will be turned power off automatically after approximately 10 minutes of no activities.</p> <p>* When the MAX hold function is enabled, the auto power off function is disabled. (APO mark is off.)</p> <p>* During waiting for being paired ( mark blinks) or during being paired with the dedicated application Multi-Tracer ( mark lights up), the auto power off function is disabled. (APO mark is off.)</p>
Bluetooth communication	<p>Bluetooth4.2 Class2</p> <p>Bluetooth wireless technology enables you to send measurements to the dedicated application "Multi-Tracer".</p>

3. NAME OF EACH PART AND HOW IT FUNCTIONS

3-1 Tester Body

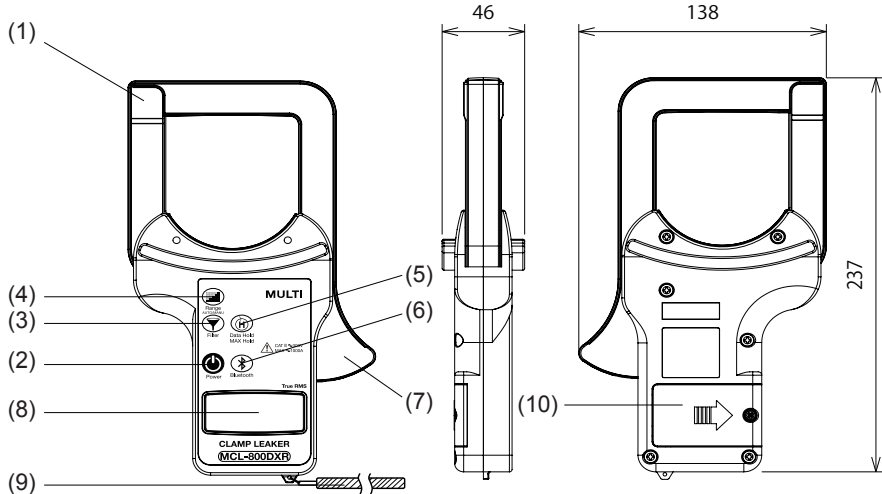

(1) Clamp-type ZCT	Clamp-type current detection sensor.
(2) Power button	To turn the power ON / OFF.
(3) Filter button	To turn the filter function ON /OFF.
(4) Range button	To switch the measurement range. Each time the button is pressed, the range setting changes in the order of AUTO → 20 mA → 200 mA → 2 A → 20 A → 200 A → 1000 A → AUTO.
(5) Data Hold MAX Hold button	To turn the data hold function and MAX hold function ON / OFF. In the manual range, each time the button is pressed, the hold mode changes in the order of data hold, MAX hold, and release from hold. In the auto range, the MAX hold function does not work. Each time the button is pressed, the hold mode is alternatively turned ON / OFF.
(6) Bluetooth button	To perform pairing with this instrument and the dedicated application "Multi-Tracer". This button is also used to send measurements to the dedicated application "Multi-Tracer". (Only applicable with MCL-800DX and MCL-800DXR)
(7) Open / close lever	To open and close the clamp type ZCT. Push it in to open the clamp.
(8) LCD	To display measurements, units, symbols, and battery status.
(9) Hand strap	To prevent dropping the instrument down.
(10) Battery cover	To cover the battery case. Remove the screw and the battery cover when you replace the batteries.

3-2 Description of the display

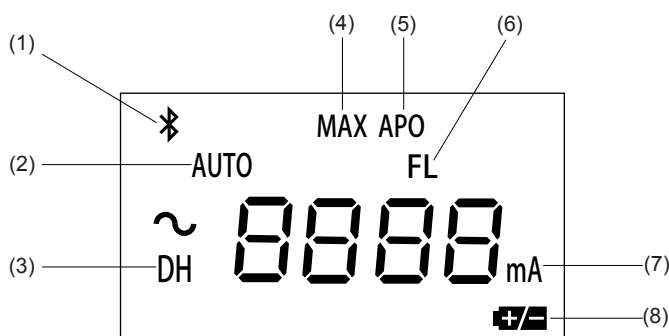

(1) Bluetooth communication indicator	Blinks while waiting for pairing with the dedicated application "Multi-Tracer". It lights up while the instrument is paired with "Multi-Tracer" (Only applicable with MCL-800DX and MCL-800DXR)
(2) Auto range indicator	Lights up while the auto range is set. It is off while the manual range is set.
(3) Data hold indicator	Lights up when the measured value is being frozen by the data hold function.
(4) MAX hold indicator	Lights up when the MAX hold function is enabled.
(5) Auto power off indicator	Lights up when the auto power off function is enabled.
(6) Filter function indicator	Lights up when the filter function is enabled.
(7) Unit indicator	Indicates the unit of the measured value.
(8) Low battery indicator	Lights up when the battery voltage drops to a certain level. * When it lights up, replace the batteries as soon as possible. Use under "Low Battery" condition may cause malfunctions.

4. MAINTENANCE

4-1 Battery replacement

- (1) Make sure the power is turned off, then remove the battery cover screw on the back with a Phillips screwdriver, and remove the battery cover.

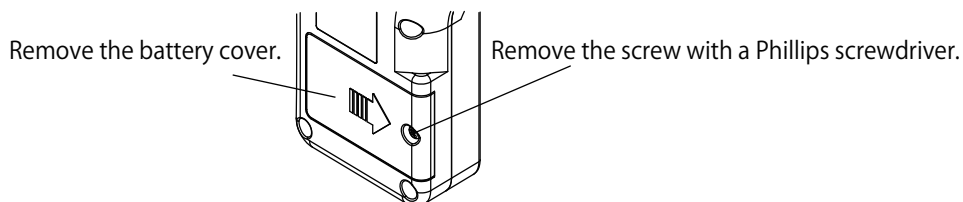

- (2) Pull the ribbon from the bottom of the batteries up slightly to lift the batteries, and then remove them.

- * Pulling the ribbon too hard may cause the battery popping out.
- * Pulling the ribbon too hard may cause the ribbon break.

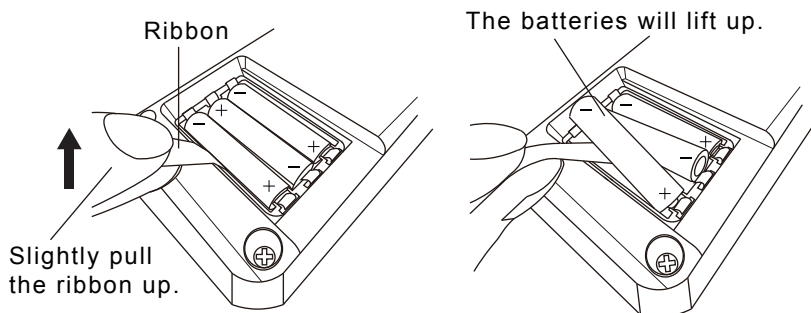

- (3) Check the battery polarity marks displayed on the battery case.
 - (4) Put three new batteries on the ribbon according to the polarity confirmed in (3).
 - (5) Attach the battery cover and tighten the screw with a Phillips screwdriver.
- * Store the ribbon inside the battery cover.

WARNING

To prevent electric shock.

- The battery cover must be reinstalled after replacing the batteries. Do not use the instrument with the battery cover removed.
- Do not replace the batteries with clamping any wire.





CAUTION

- Incorrect battery polarity may cause battery leakage or damage to the instrument circuit.
- Never disassemble the battery or throw it into a fire as it is extremely dangerous.
- If you leave the batteries with wrong polarity, they will overheat and become unusable. Even if you set the batteries correctly again, the batteries cannot be used.
- Dispose of the used batteries according to the rules in the designated place.

5. MEASURING PROCEDURE

5-1 Load current measurement

- (1) Press the Power button  once to turn the power on.
- (2) Right after the power is turned ON, the auto range is set.

To use the instrument in the manual range, set it with the Range button . Each time the Range button  is pressed, the range setting changes in the order of AUTO → 20 mA → 200 mA → 2 A → 20 A → 200 A → 1000 A → AUTO.

- (3) Open the clamp-type ZCT section, clamp the wire to be measured, and completely close it.
(Close the ZCT gently.)

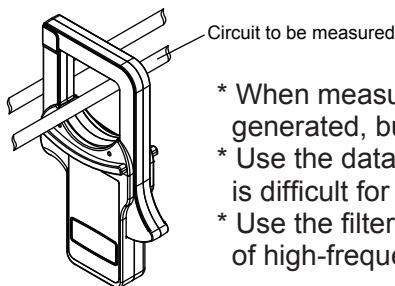

- * When measuring a large current, vibration noise may be generated, but there is no safety problem.
- * Use the data hold and MAX hold functions in places where it is difficult for you to read the display.
- * Use the filter function for circuits that contain a large amount of high-frequency.

- (4) Read the display. (When the input exceeds the measurable range, "OL" is displayed.)

When the auto power off function turns the power OFF while reading, press the Power button  once to turn the power ON again.

- (5) After the measurement is completed, remove the instrument from the clamped circuit and press the Power button  once to turn the power OFF.



CAUTION

- Excessive current applied to CT may cause overheating and damage to the instrument.
Do not apply any input current exceeding the measurable range to the instrument.
- This is a precision instrument. Handle with paying attention not to apply excessive force such as big impact or vibration.
- Open and close the clamp part gently.
- A "click" sound will be made after the Power button is turned on. This sound is normal because it is the operating sound of the range switching relay.

5-2 Leakage current measurement

(1) Grounding wire

Clamp the grounding wire in the same way as the load current measurement.

(2) Electrical circuits other than the grounding wire

The operation for measurement is the same as the measurement of grounding wire current. However, for single-phase two-wire system leakage current measurement, clamp them together. Also, for single-phase three-wire and three-phase three-wire system leakage current measurements, clamp three wires together.

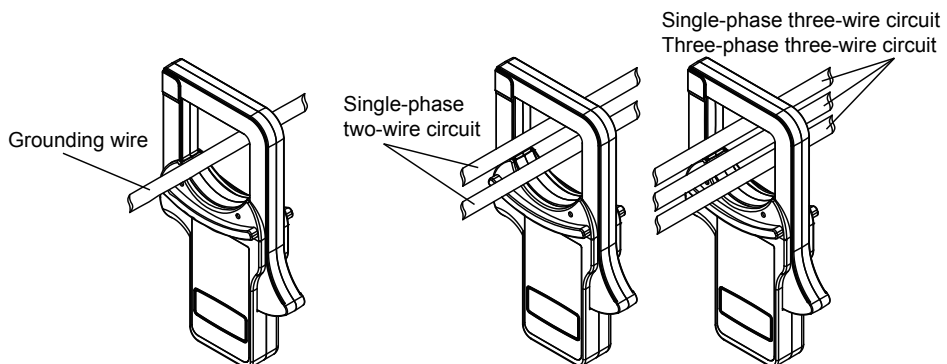

5-3 Auxiliary function for measurement

Manual range

Each time the Range button  is pressed, the range setting changes in the order of

AUTO → 20 mA → 200 mA → 2 A → 20 A → 200 A → 1000 A → AUTO.

After the range is switched, the set range is displayed for approximately 1 second.

* Right after the power is turned ON the auto range is set.

Data hold

Press the Data Hold MAX Hold button  once.

The "DH" mark lights up and the measured value when the button is pressed is held.

Each time the button is pressed, the function changes as follows.

Auto range: Data Hold → Cancel → Data Hold →

Manual range: Data Hold → MAX Hold → Cancel → Data Hold →

MAX hold (* Manual range only)

Press the Range button  to set the manual range.

Press the Data Hold MAX Hold button  twice.

The "MAX" mark lights up and the maximum value is updated at each sampling from when the button is pressed.

Press the Data Hold MAX Hold button  again to cancel the MAX Hold function.

Filter

Press the Filter button  once.

The "FL" mark lights up and the measured value with the high frequency suppressed is displayed.

Press the button again to cancel.

(Cut-off frequency: 150 Hz)

Bluetooth communication

Press the Bluetooth button  once.

The  mark flashes on the instrument display.

When the  mark flashes, try to be paired with the dedicated application "Multi-Tracer".

When pairing is made successfully, the  mark changes from flashing to lit.

While they are paired, each time  is pressed, the measured value is sent to the dedicated application "Multi-Tracer".

(Only applicable with MCL-800DX and MCL-800DXR)

6. Bluetooth COMMUNICATION (MCL-800DX, MCL-800DXR)

MCL-800DX and MCL-800DXR support the Bluetooth communication. Communicating with the dedicated application "Multi-Tracer" on smartphones and tablets, you can check the measurement data and save them.

* During waiting for being paired or being paired with the dedicated application "Multi-Tracer", the auto power off function is disabled.

Download and install the dedicated application "Multi-Tracer" from the App Store if your mobile device is an iPhone or iPad, or from the Google Play if your device is an Android device.

* You have to have an Apple ID to download from the App Store.

* You have to have a Google account to download from the Google Play.

* For information how to get an Apple ID or a Google account, please contact each mobile device supplier.



CAUTION

- This product employs radio equipment that has obtained construction design certification as a radio station for low-power data communication systems based on the Radio Law.
EYSHCN:001-A10745
- The communicable distance greatly depends on the surrounding radio wave conditions and physical conditions (such as obstacles).
- This instrument uses the 2.4GHz band. When this instrument is used near other wireless devices using the same frequency as this instrument, radio wave interference may occur between this instrument and the other wireless devices. When radio wave interference occurs, stop the other wireless devices or change the location where you use the instrument to avoid radio wave interference.
- The Bluetooth communication is not guaranteed to work on all mobile devices.
- The dedicated application "Multi-Tracer" can be used free of charge. However the user is responsible for the Internet connection costs for downloading and using the application.
- The dedicated application "Multi-Tracer" is not guaranteed to work on all mobile devices.

7. AFTER-SALE SERVICE

When the instrument failed, contact your dealer or distributor.

When sending the instrument for repair, wrap the instrument in cushioning material, store it in a sturdy box, and send it to us with the following information.

1. Customer's name, address, and telephone number
2. Description of the failure
3. Model number
4. Product serial number (if available)
5. Date of purchase
6. Where you purchased the product

8. WARRANTY

This instrument is shipped after rigorous in-house inspection, but we will repair it free of charge if the cause of the failure is determined to be our responsibility, such as a manufacturing defect. The warranty period for this product is 15 months from the date of purchase.

MEMO

MULTI

Let's Create
New Concepts of
Instruments